

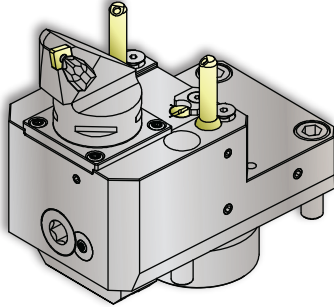

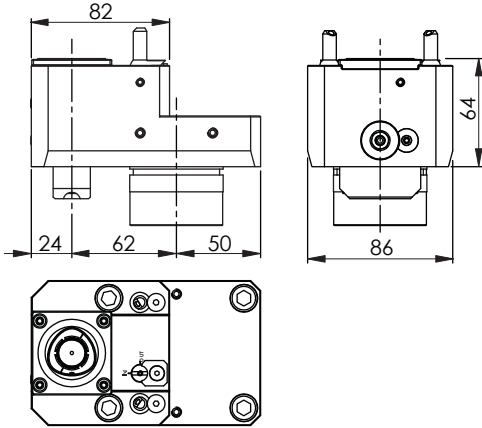



## OKUMA

Length Turning Tool Holder / Überdrehhalter  
 Porta Utensili per Esterni / Porte Outil de Dressage  
 外径ターニングホルダー

Lathe Linear Static • LLS C4-1 R				
Machine Types	LT2000 EX V16 M / MY			
  				
#				# 
14910001120	Capto C4	 100 bar		14430100980

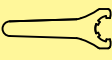
### Notes / Notizen / Note / Notes / ㄨㄛ

Please check the machine strokes and the neighbor stations on potential overlaps - Bitte die Verfahrswege und die Nachbarstationen auf mögliche Überschneidungen überprüfen  
 Si prega di verificare i percorsi e le stazioni adiacenti di potenziali sovrapposizioni - Vérifier les courses et qu'il n'y a pas de collisions possibles avec les stations voisines  
 常に機械のストロークと、隣接するステーションにオーバーラップが無いが確認してください。  
 Design data and dimensions subject to change - Konstruktions- und Massänderungen vorbehalten  
 Cambiamento della costruzione e delle misure riservato - Droit de modification de structure et de cotes réservées  
 設計仕様および寸法は通知することなく変更されます

